

AA-1060-SP Parts List

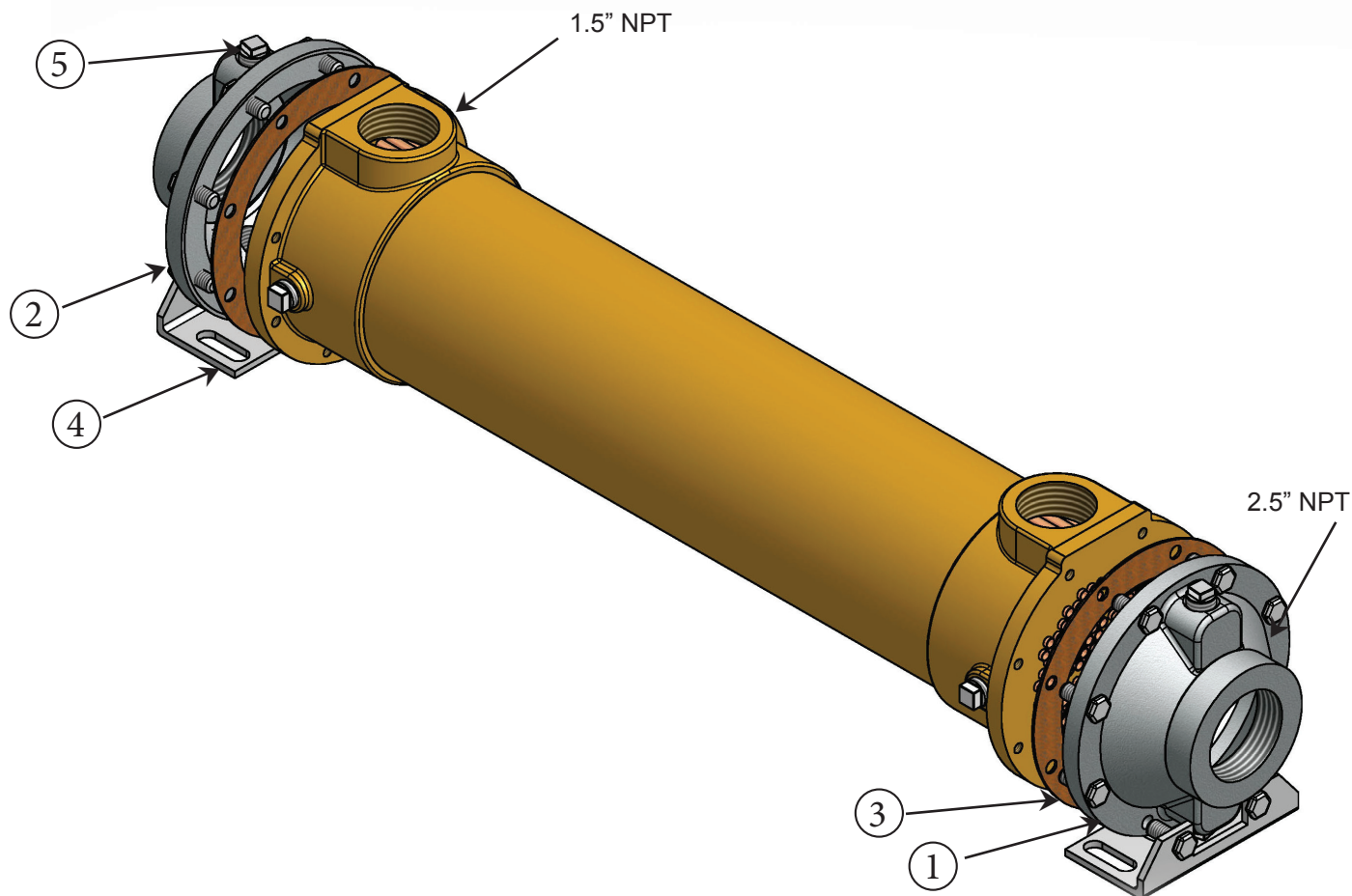

<u>Item</u>	<u>Description</u>	<u>Material</u>	<u>Part Number</u>	<u>Price Each</u>	<u>Stock</u>
1.	End Bonnet / In-Out	Cast Iron	203-0136		Yes
2.	End Bonnet / In-Out	Cast Iron	203-0136		Yes
1.	End Bonnet / In-Out	Cast Bronze	203-0137		Yes
2.	End Bonnet / In-Out	Cast Bronze	203-0137		Yes
1.	End Bonnet / In-Out	Stainless Steel	203-0186		Yes
2.	End Bonnet / In-Out	Stainless Steel	203-0186		Yes
3.	Gasket / Front-Back	Hypalon (CORK COMPOSITE)	302-1003		Yes
3.	Gasket / Front-Back	High Temp.(DURLON 8500)	302-1013		Yes
4.	Foot Bracket	Steel	203-0044		Yes
5.	Zinc Anode	Brass Fitting, Zinc Rod	301-0004		Yes

