

AA-1224-FP Parts List

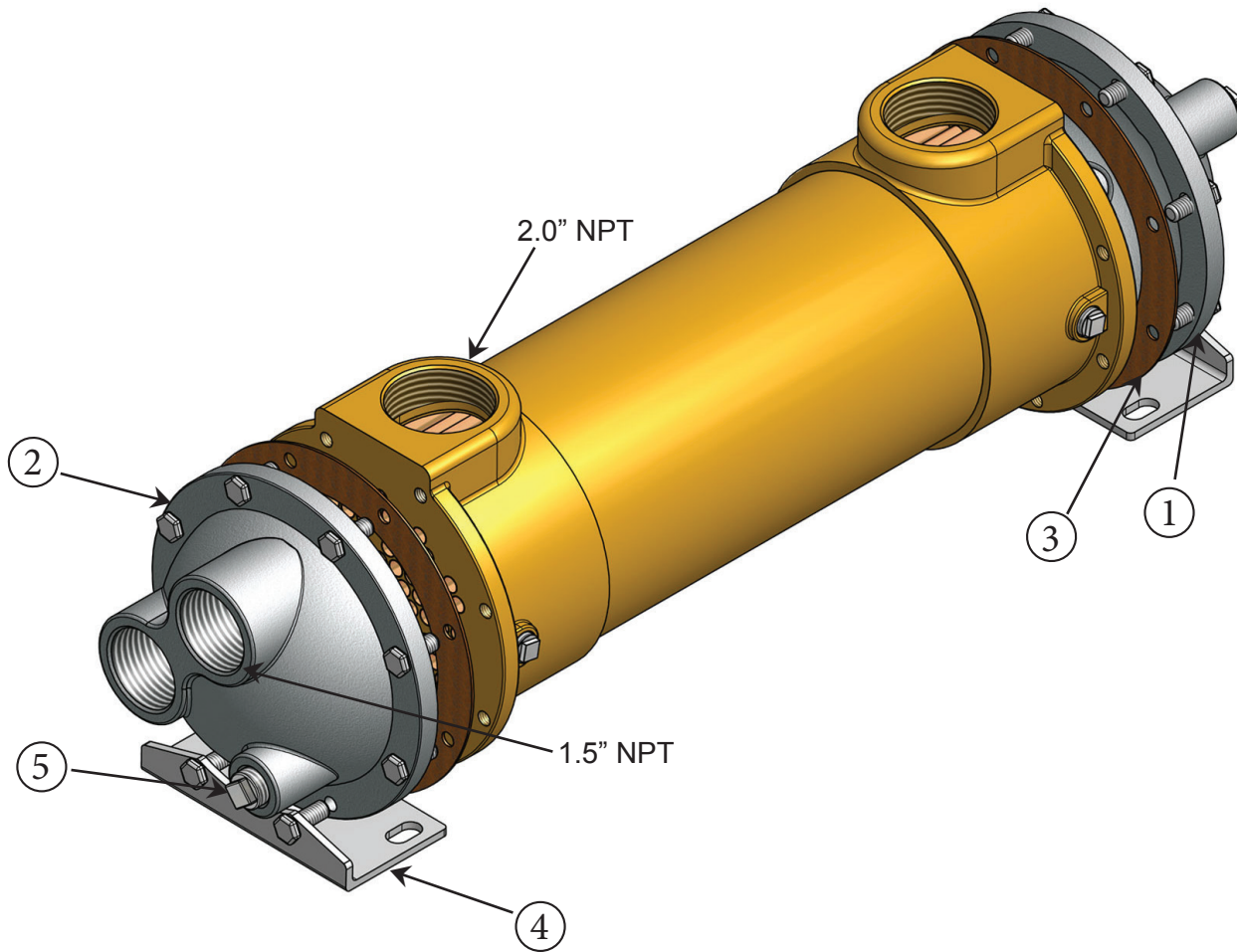

<u>Item</u>	<u>Description</u>	<u>Material</u>	<u>Part Number</u>	<u>Price Each</u>	<u>Stock</u>
1.	End Bonnet / In-Out	Cast Iron	204-0005		Yes
2.	End Bonnet / Return	Cast Iron	204-0006		Yes
1.	End Bonnet / In-Out	Cast Bronze	204-0031		Yes
2.	End Bonnet / Return	Cast Bronze	204-0032		Yes
1.	End Bonnet / In-Out	Stainless Steel	204-0074		Yes
2.	End Bonnet / Return	Stainless Steel	204-0075		Yes
3.	Gasket / Front-Back	Hypalon (CORK COMPOSITE)	302-1004		Yes
3.	Gasket / Front-Back	High Temp. (DURLON 8500)	302-1014		Yes
4.	Foot Bracket	Steel	203-0076		Yes
5.	Zinc Anode	Brass Fitting, Zinc Rod	301-0003		Yes

Zinc Anode Schematic

