

AA-1260-TP Parts List

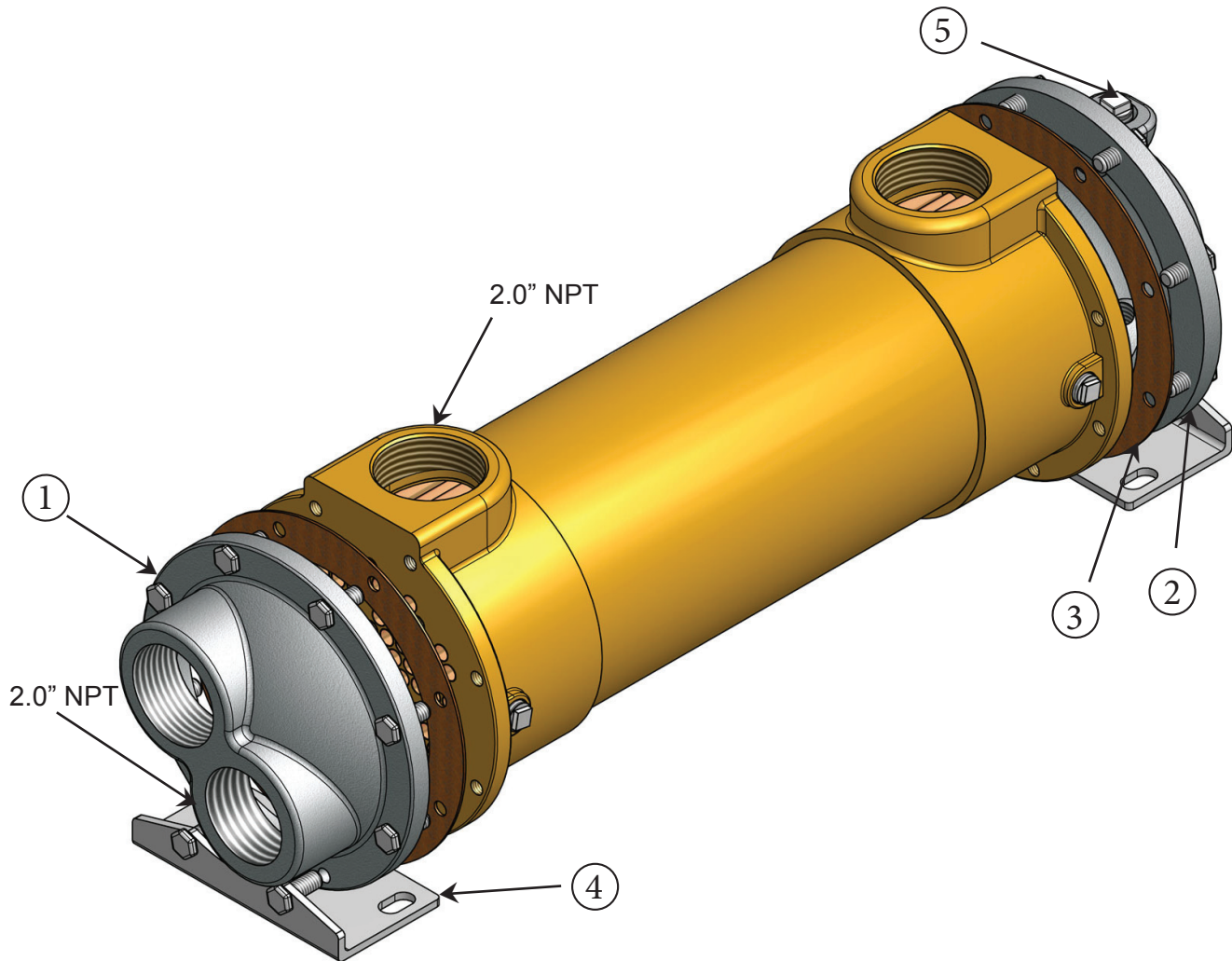

<u>Item</u>	<u>Description</u>	<u>Material</u>	<u>Part Number</u>	<u>Stock</u>
1.	End Bonnet / In-Out	Cast Iron	204-0003	Yes
2.	End Bonnet / Return	Cast Iron	204-0004	Yes
1.	End Bonnet / In-Out	Cast Bronze	204-0029	Yes
2.	End Bonnet / Return	Cast Bronze	204-0030	Yes
1.	End Bonnet / In-Out	Stainless Steel	204-0072	Yes
2.	End Bonnet / Return	Stainless Steel	204-0073	Yes
3.	Gasket / Front-Back	Hypalon (CORK COMPOSITE)	302-1004	Yes
3.	Gasket / Front-Back	High Temp.(DURLON 8500)	302-1014	Yes
4.	Foot Bracket	Steel	204-0076	Yes
5.	Zinc Anode	Brass Fitting, Zinc Rod	301-0003	Yes

Zinc
Anode
Schematic

