

AA-1684-TP Parts List

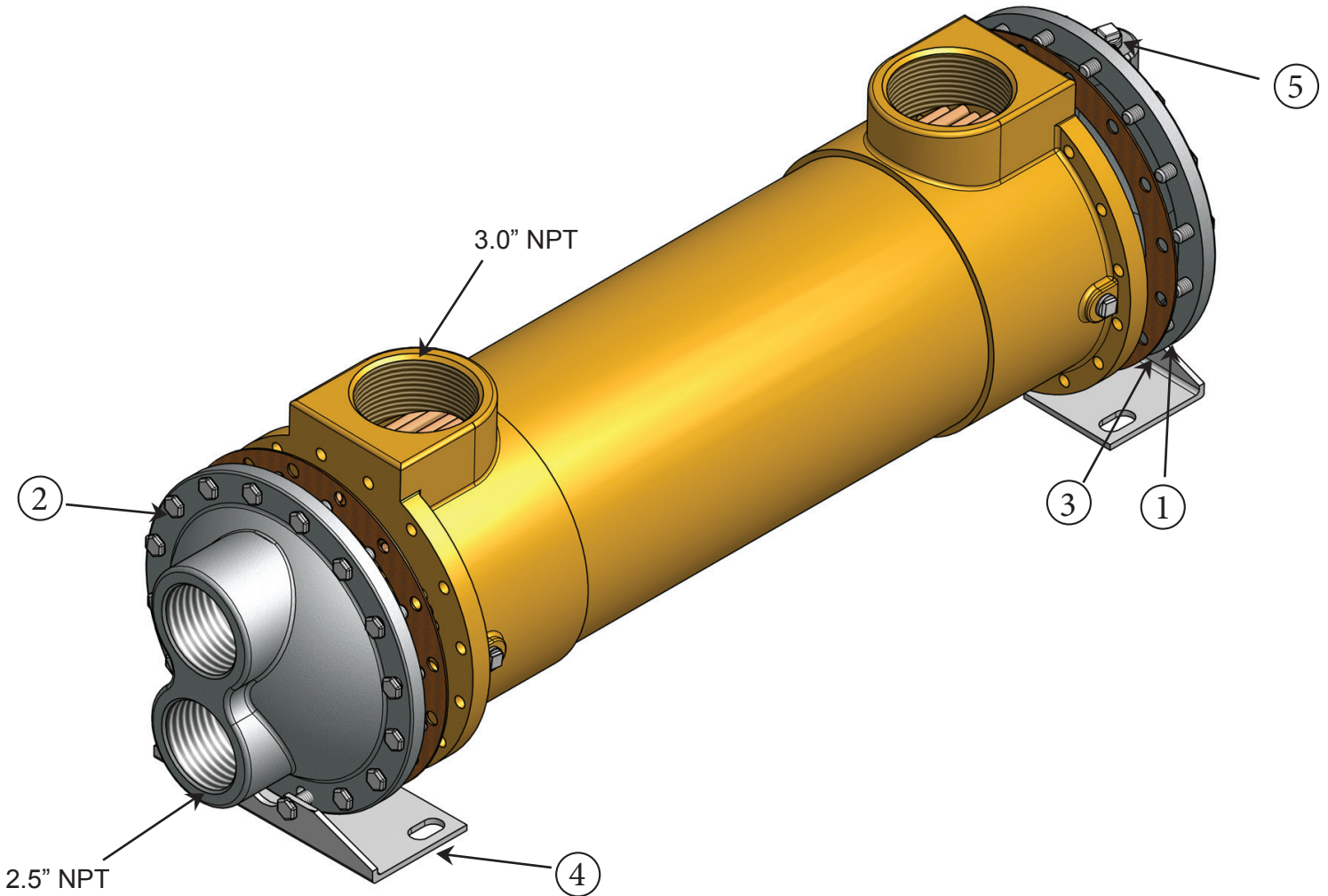

<u>Item</u>	<u>Description</u>	<u>Material</u>	<u>Part Number</u>	<u>Stock</u>
1.	End Bonnet / In-Out	Cast Iron	205-0309	Yes
2.	End Bonnet / Return	Cast Iron	205-0310	Yes
1.	End Bonnet / In-Out	Cast Bronze	205-0279	Yes
2.	End Bonnet / Return	Cast Bronze	205-0280	Yes
1.	End Bonnet / In-Out	Stainless Steel	205-0372	Yes
2.	End Bonnet / Return	Stainless Steel	205-0383	Yes
3.	Gasket / Front-Back	Hypalon (CORK COMPOSITE)	302-1005	Yes
3.	Gasket / Front-Back	High Temp.(DURLON 8500)	302-1150	Yes
4.	Foot Bracket	Steel	205-0058	Yes
5.	Zinc Anode	Brass Fitting, Zinc Rod	301-0003	Yes

