

AA-624-FP Parts List

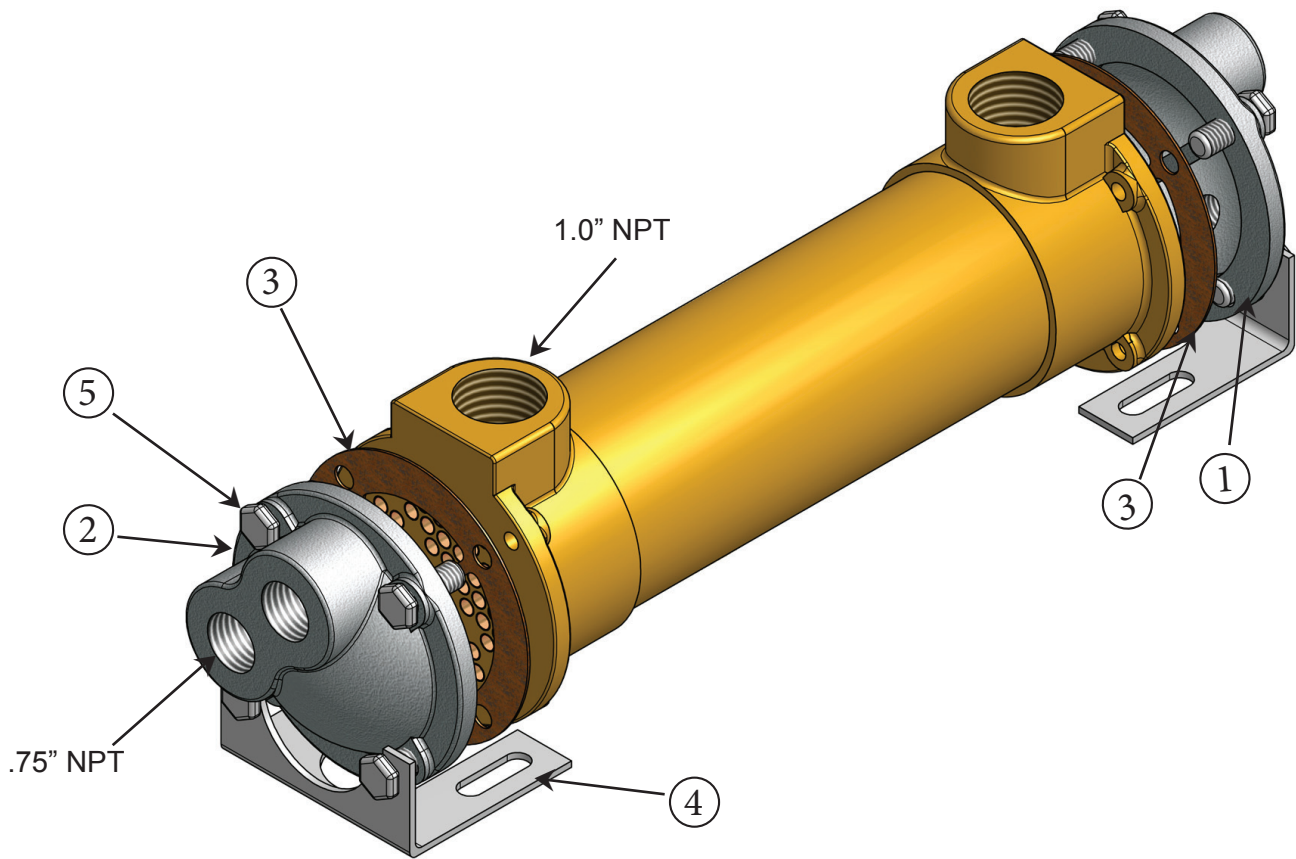

Item	Description	Material	Part Number	Stock
1.	End Bonnet / In-Out	Cast Iron	206-0010	Yes
2.	End Bonnet / Return	Cast Iron	206-0011	Yes
1.	End Bonnet / In-Out	Cast Bronze	206-0027	Yes
2.	End Bonnet / Return	Cast Bronze	206-0028	Yes
1.	End Bonnet / In-Out	Stainless Steel	206-0032	Yes
2.	End Bonnet / Return	Stainless Steel	206-0033	Yes
3.	Gasket / Front-Back	Hypalon (CORK COMPOSITE)	302-1016	Yes
3.	Gasket / Front-Back	High Temp.(DURLON 8500)	302-1007	Yes
4.	Foot Bracket	Steel	206-0012	Yes
5.	Zinc Anode	Brass Fitting, Zinc Rod	301-0004	Yes

