

CS-1272-FP Parts List

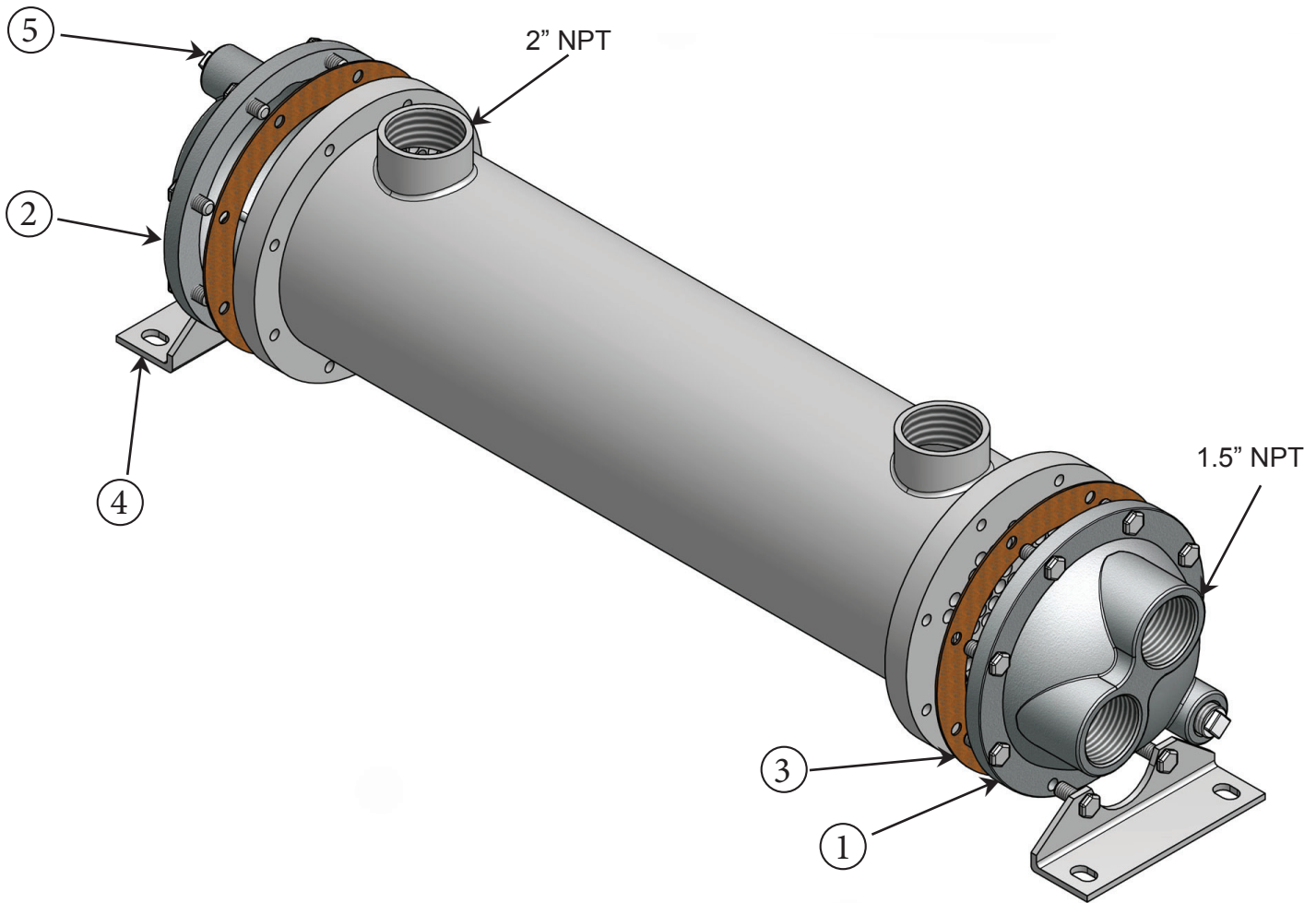

<u>Item</u>	<u>Description</u>	<u>Material</u>	<u>Part Number</u>	<u>Stock</u>
1.	End Bonnet / In-Out	Cast Iron	204-0005	Yes
2.	End Bonnet / Return	Cast Iron	204-0006	Yes
1.	End Bonnet / In-Out	Cast Bronze	204-0031	Yes
2.	End Bonnet / Return	Cast Bronze	204-0032	Yes
1.	End Bonnet / In-Out	Stainless Steel	204-0074	Yes
2.	End Bonnet / Return	Stainless Steel	204-0075	Yes
3.	Gasket / Front-Back	Hypalon (CORK COMPOSITE)	302-1004	Yes
3.	Gasket / Front-Back	High Temp.(DURLON 8500)	302-1014	Yes
4.	Foot Bracket	Steel	204-0245	Yes
5.	Zinc Anode	Brass Fitting, Zinc Rod	301-0003	Yes

Zinc Anode Schematic

