

CS-1736-FP Parts List

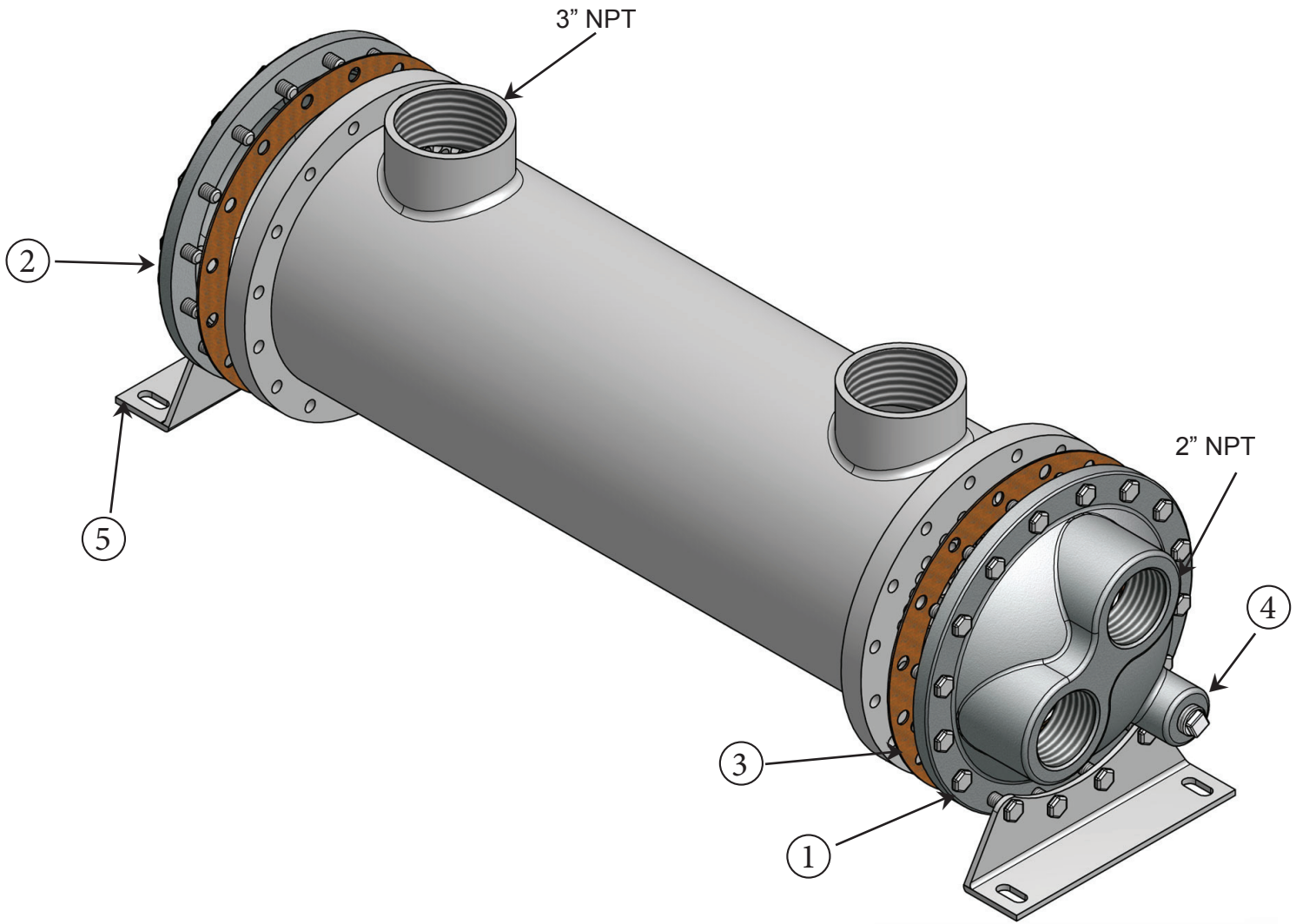

<u>Item</u>	<u>Description</u>	<u>Material</u>	<u>Part Number</u>	<u>Price Each</u>	<u>Stock</u>
1.	End Bonnet / In-Out	Cast Iron	205-0005		Yes
2.	End Bonnet / Return	Cast Iron	205-0006		Yes
1.	End Bonnet / In-Out	Cast Bronze	205-0031		Yes
2.	End Bonnet / Return	Cast Bronze	205-0032		Yes
1.	End Bonnet / In-Out	Stainless Steel	205-0056		Yes
2.	End Bonnet / Return	Stainless Steel	205-0057		Yes
3.	Gasket / Front-Back	Hypalon	302-1005		Yes
3.	Gasket / Front-Back	High Temperature	302-1015		Yes
4.	0.5" NPT Thread 1.75" by 0.63" OD	Zinc Anode	301-0003		Yes
5.	Foot Bracket	Steel	205-0161		Yes