

CS-2096-TP Parts List

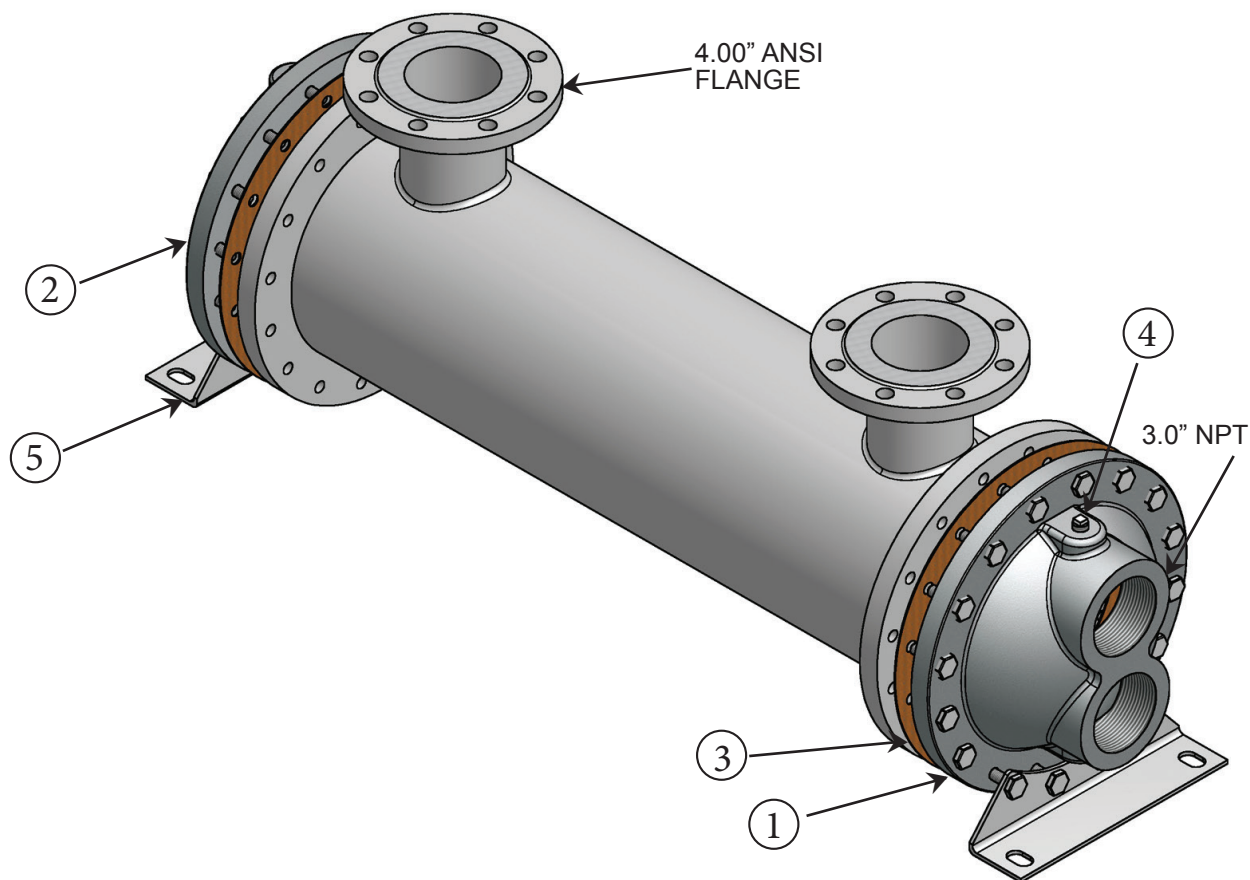

<u>Item</u>	<u>Description</u>	<u>Material</u>	<u>Part Number</u>	<u>Price Each</u>	<u>Stock</u>
1.	End Bonnet / In-Out	Cast Iron	208-0003		Yes
2.	End Bonnet / Return	Cast Iron	208-0004		Yes
1.	End Bonnet / In-Out	Cast Bronze	208-0008		Yes
2.	End Bonnet / Return	Cast Bronze	208-0009		Yes
1.	End Bonnet / In-Out	Stainless Steel	208-0023		Yes
2.	End Bonnet / Return	Stainless Steel	208-0028		Yes
3.	Gasket / Front-Back	Hypalon	302-1022		Yes
3.	Gasket / Front-Back	High Temperature	302-1013		Yes
4.	0.50" NPT Thread, 1.75" by 0.63"	Zinc Anode	301-0003		Yes
5.	Foot Bracket	Steel	208-0020		Yes