

CS-836-FP Parts List

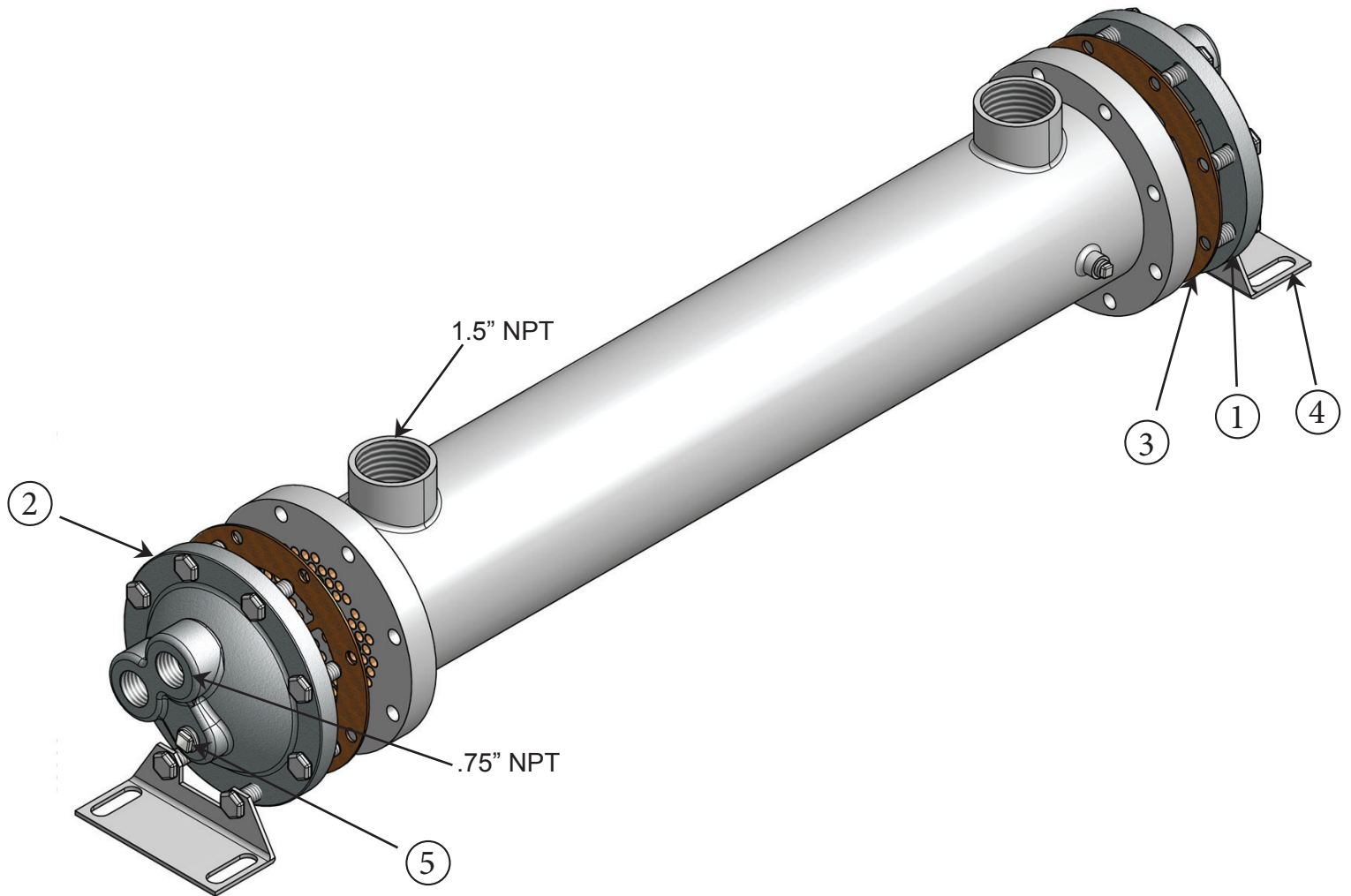

Item	Description	Material	Part Number	Stock
1.	End Bonnet / In-Out	Cast Iron	207-0010	Yes
2.	End Bonnet / Return	Cast Iron	207-0011	Yes
1.	End Bonnet / In-Out	Cast Bronze	207-0015	Yes
2.	End Bonnet / Return	Cast Bronze	207-0016	Yes
1.	End Bonnet / In-Out	Stainless Steel	207-0020	Yes
2.	End Bonnet / Return	Stainless Steel	207-0021	Yes
3.	Gasket / Front-Back	Hypalon (CORK COMPOSITE)	302-1019	Yes
3.	Gasket / Front-Back	High Temp.(DURLON 8500)	302-1017	Yes
4.	Foot Bracket	Steel	207-0043	Yes
5.	Zinc Anode	Brass Fitting, Zinc Rod	301-0004	Yes

