

FBF-1024-TP Parts List

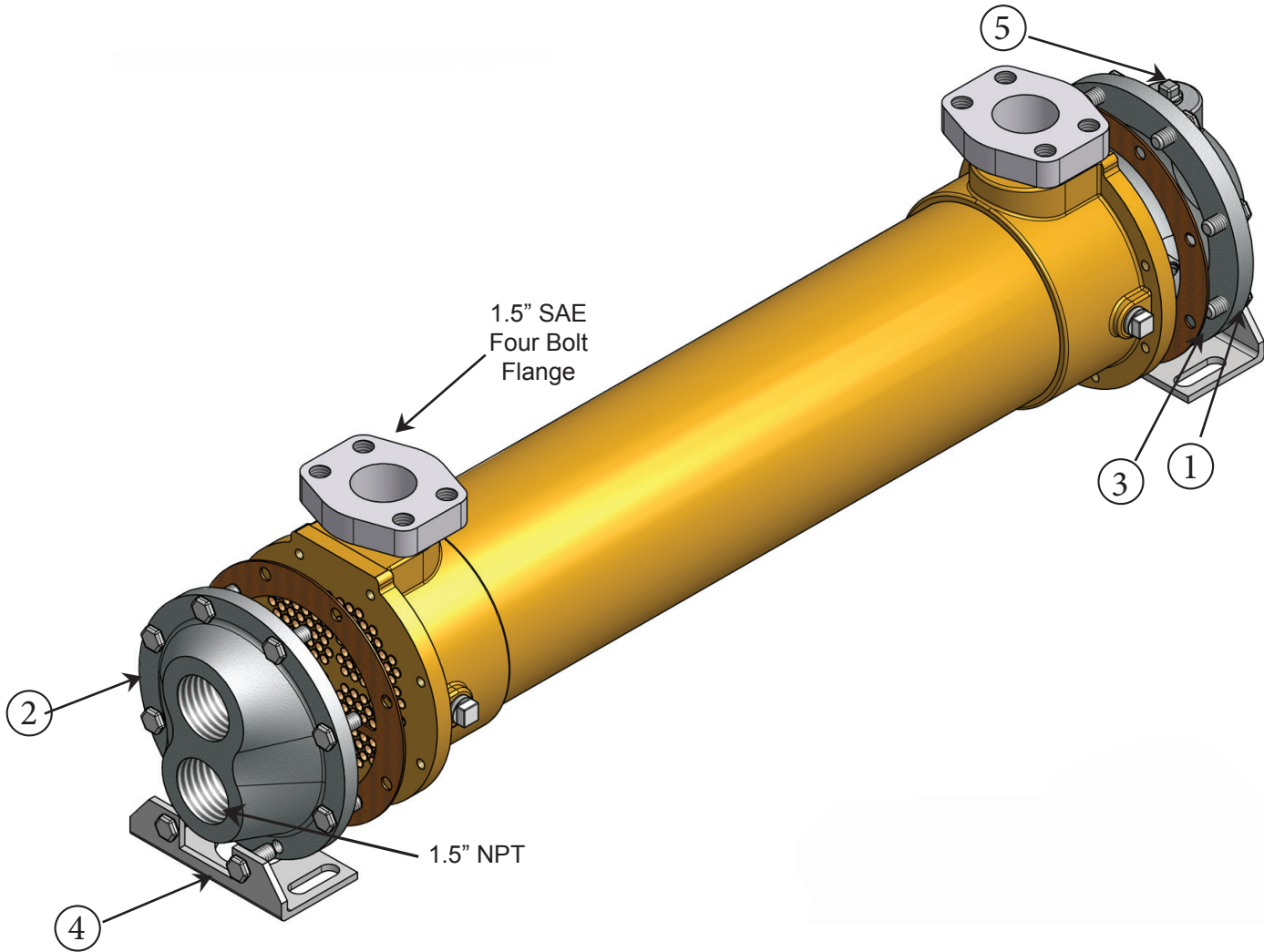

<u>Item</u>	<u>Description</u>	<u>Material</u>	<u>Part Number</u>	<u>Stock</u>
1.	End Bonnet / In-Out	Cast Iron	203-0003	Yes
2.	End Bonnet / Return	Cast Iron	203-0004	Yes
1.	End Bonnet / In-Out	Cast Bronze	203-0017	Yes
2.	End Bonnet / Return	Cast Bronze	203-0018	Yes
1.	End Bonnet / In-Out	Stainless Steel	203-0040	Yes
2.	End Bonnet / Return	Stainless Steel	203-0041	Yes
3.	Gasket / Front-Back	Hypalon (CORK COMPOSITE)	302-1003	Yes
3.	Gasket / Front-Back	High Temp.(DURLON 8500)	302-1013	Yes
4.	Foot Bracket	Steel	203-0044	Yes
5.	Zinc Anode	Brass Fitting, Zinc Rod	301-0004	Yes

