

FBF-1660-FP Parts List

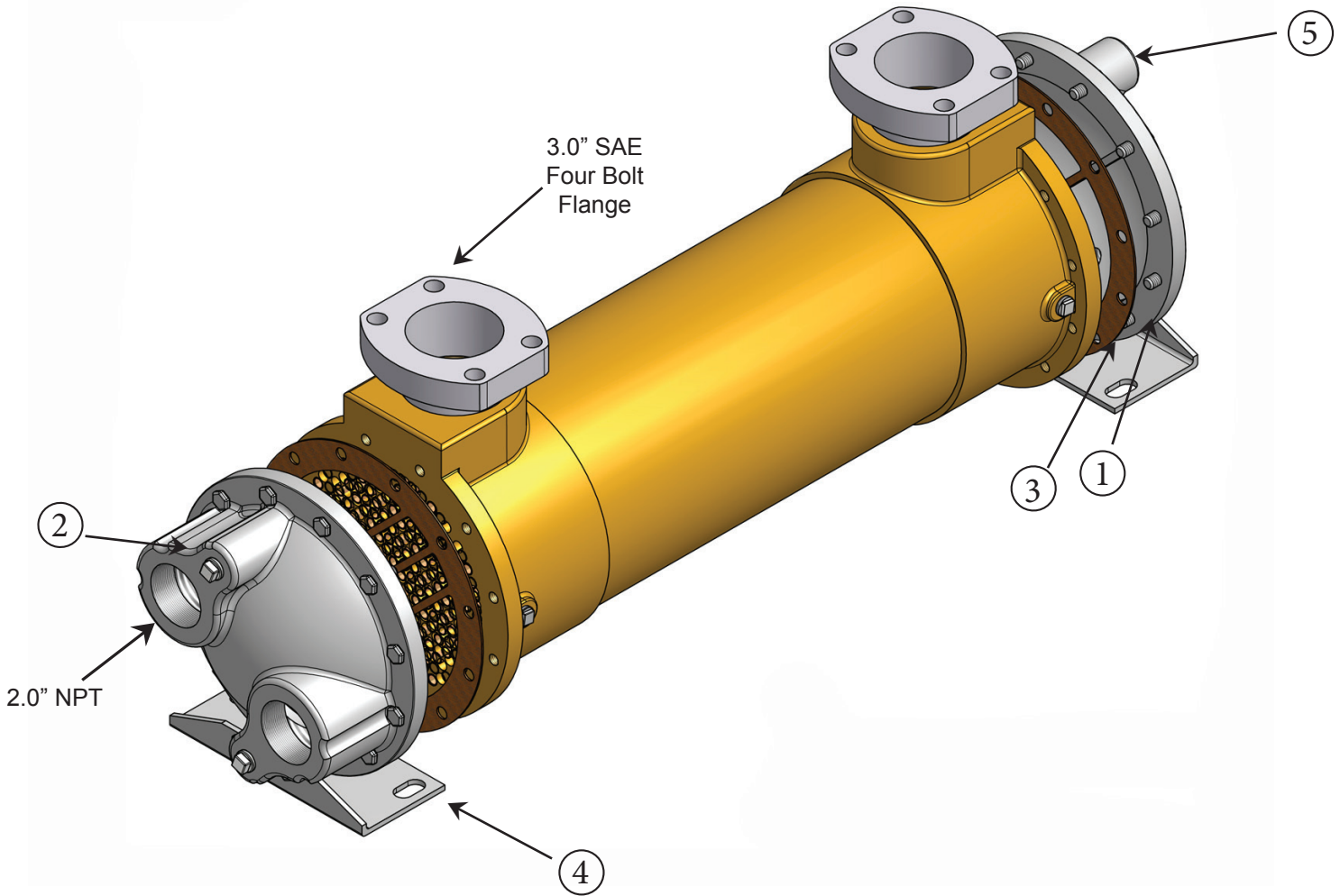

<u>Item</u>	<u>Description</u>	<u>Material</u>	<u>Part Number</u>	<u>Stock</u>
1.	End Bonnet / In-Out	Cast Iron	205-0153	Yes
2.	End Bonnet / Return	Cast Iron	205-0154	Yes
1.	End Bonnet / In-Out	Cast Bronze	205-0158	Yes
2.	End Bonnet / Return	Cast Bronze	205-0159	Yes
1.	End Bonnet / In-Out	Stainless Steel	205-0340	Yes
2.	End Bonnet / Return	Stainless Steel	205-0341	Yes
3.	Gasket / Front-Back	Hypalon (CORK COMPOSITE)	302-1005	Yes
3.	Gasket / Front-Back	High Temp. (DURLON 8500)	302-1015	Yes
4.	Foot Bracket	Steel	205-0058	Yes
5.	Zinc Anode	Brass Fitting, Zinc Rod	301-0003	Yes

