

SAE-1003-TP Parts List

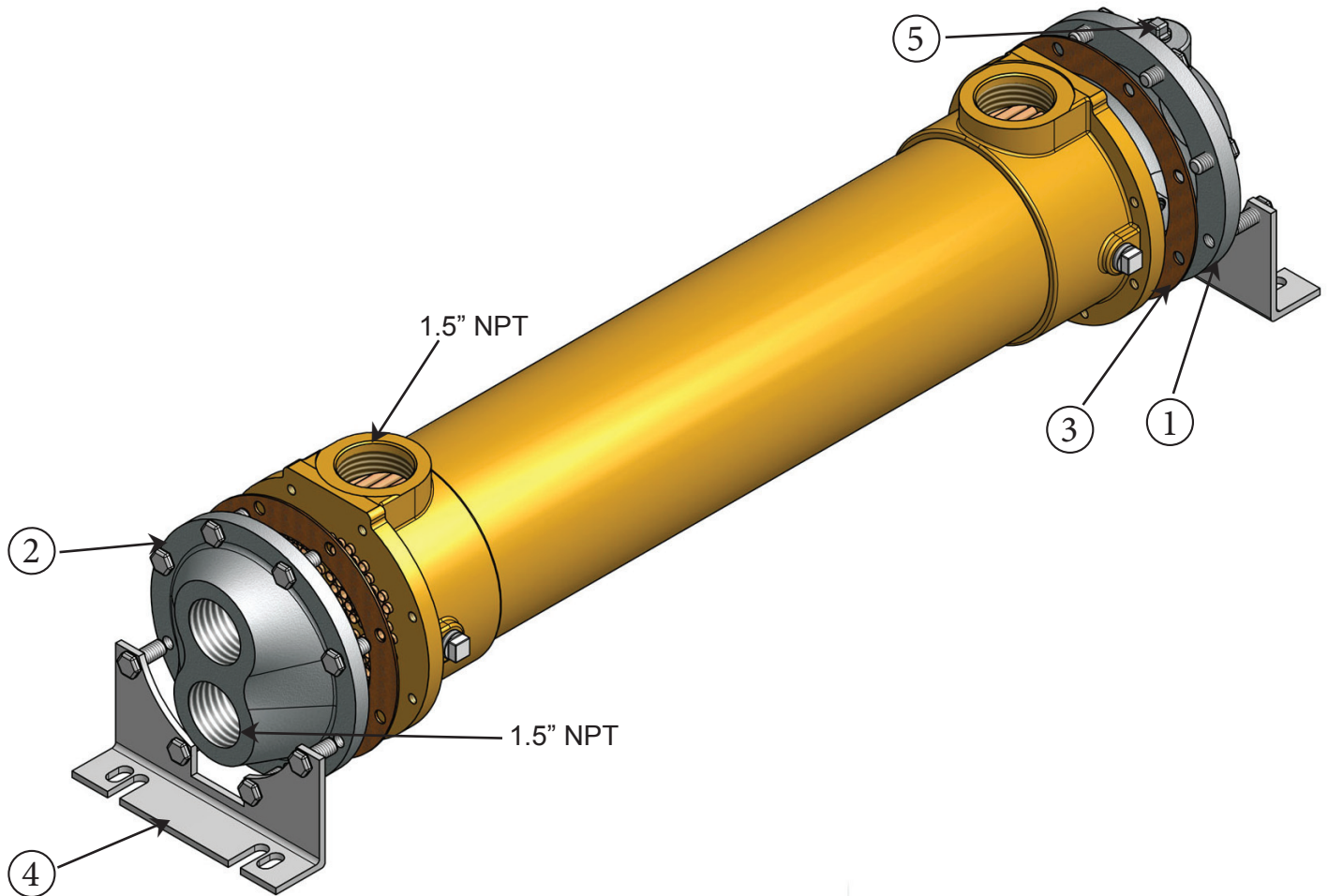

Item	Description	Material	Part Number	Stock
1.	End Bonnet / In-Out	Cast Iron	203-0003	Yes
2.	End Bonnet / Return	Cast Iron	203-0004	Yes
1.	End Bonnet / In-Out	Cast Bronze	203-0017	Yes
2.	End Bonnet / Return	Cast Bronze	203-0018	Yes
1.	End Bonnet / In-Out	Stainless Steel	203-0040	Yes
2.	End Bonnet / Return	Stainless Steel	203-0041	Yes
3.	Gasket / Front-Back	Hypalon (CORK COMPOSITE)	302-1003	Yes
3.	Gasket / Front-Back	High Temp. (DURLON 8500)	302-1013	Yes
4.	Foot Bracket	Steel	203-0087	Yes
5.	Zinc Anode	Brass Fitting, Zinc Rod	301-0004	Yes

