

# SAE-1004-SP Parts List

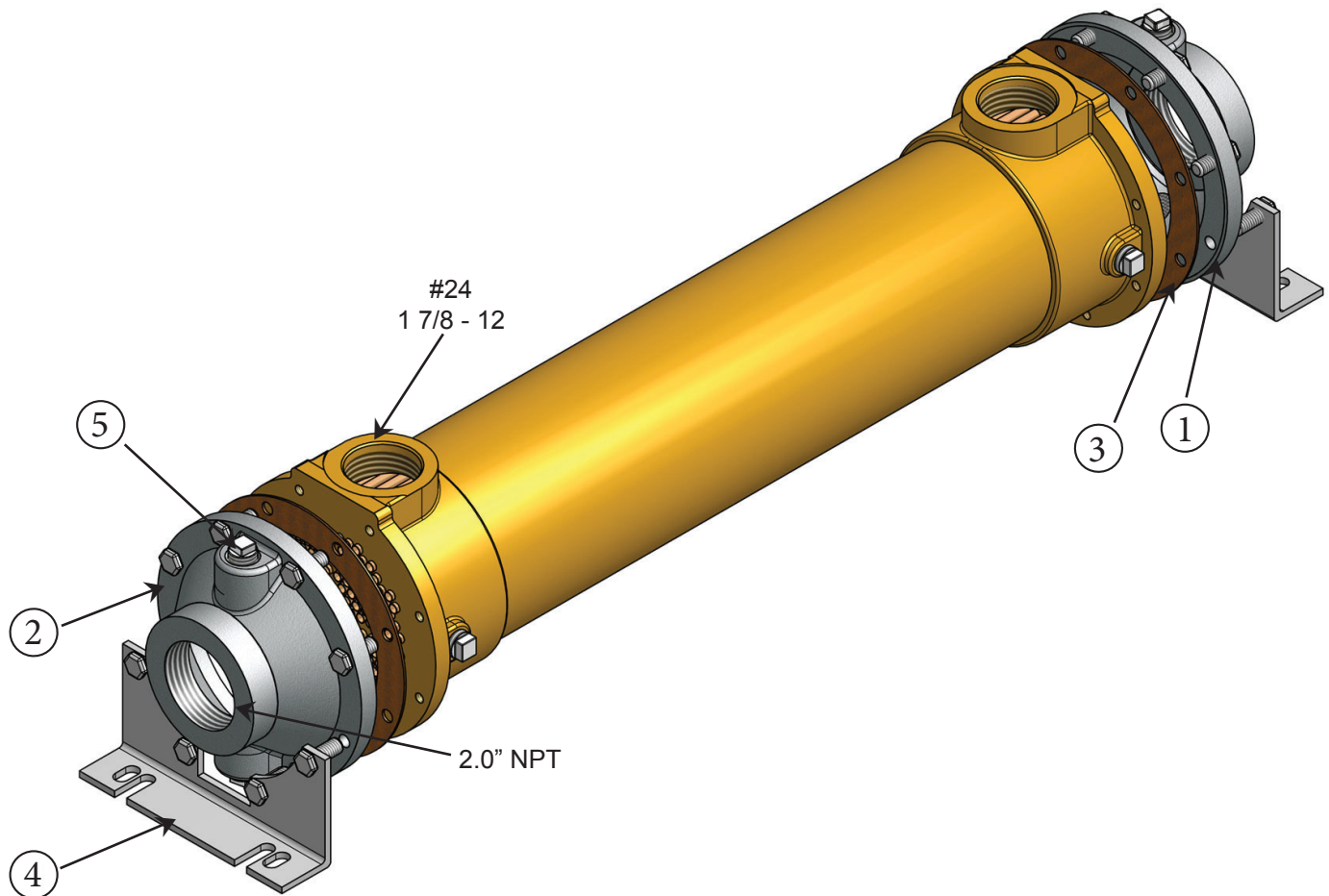

| Item | Description         | Material                 | Part Number | Stock |
|------|---------------------|--------------------------|-------------|-------|
| 1.   | End Bonnet / In-Out | Cast Iron                | 203-0002    | Yes   |
| 2.   | End Bonnet / In-Out | Cast Iron                | 203-0002    | Yes   |
| 1.   | End Bonnet / In-Out | Cast Bronze              | 203-0016    | Yes   |
| 2.   | End Bonnet / In-Out | Cast Bronze              | 203-0016    | Yes   |
| 1.   | End Bonnet / In-Out | Stainless Steel          | 203-0039    | Yes   |
| 2.   | End Bonnet / In-Out | Stainless Steel          | 203-0039    | Yes   |
| 3.   | Gasket / Front-Back | Hypalon (CORK COMPOSITE) | 302-1003    | Yes   |
| 3.   | Gasket / Front-Back | High Temp.(DURLON 8500)  | 302-1013    | Yes   |
| 4.   | Foot Bracket        | Steel                    | 203-0087    | Yes   |
| 5.   | Zinc Anode          | Brass Fitting, Zinc Rod  | 301-0004    | Yes   |

