

SAE-1005-FP Parts List

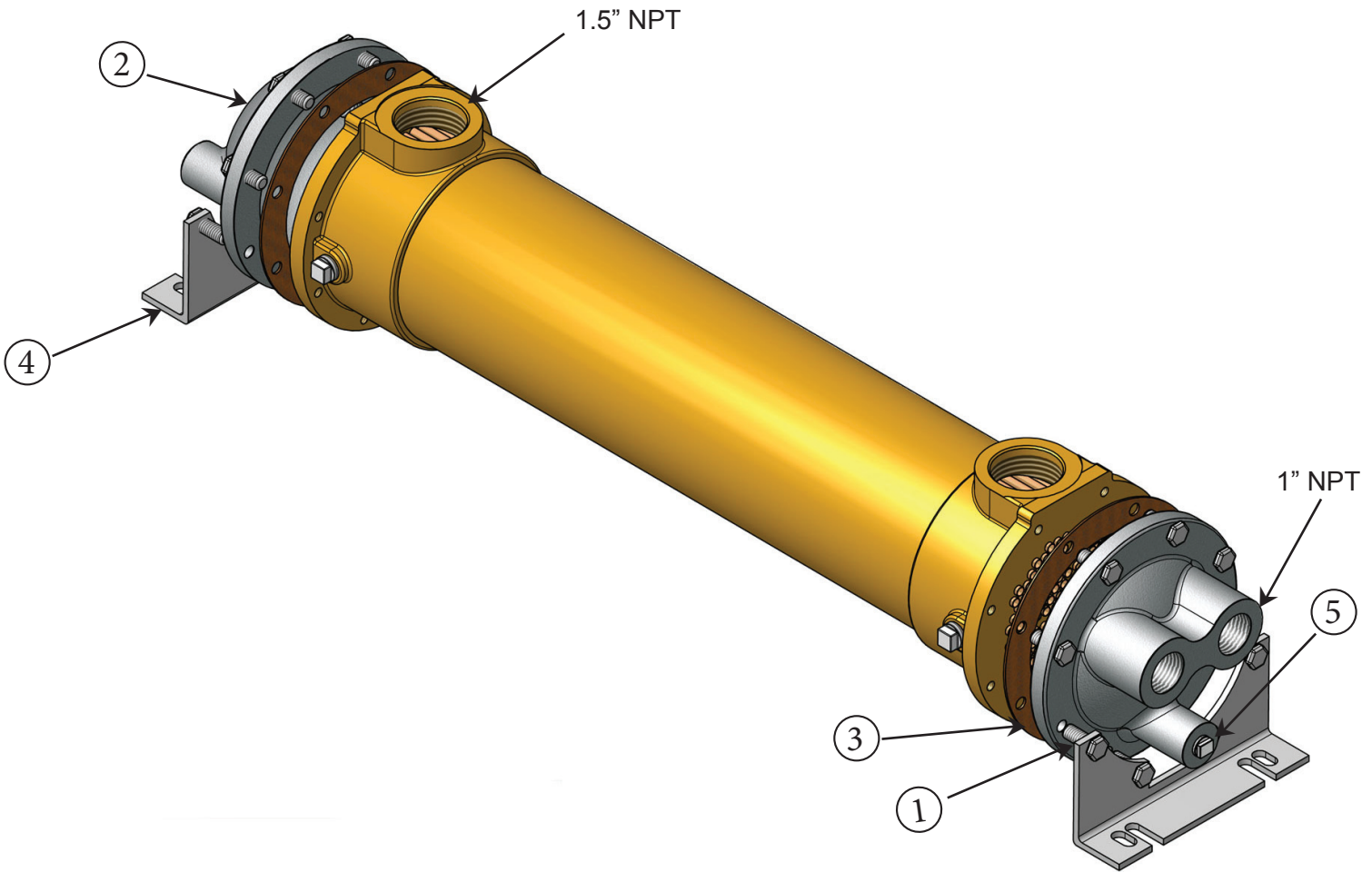

<u>Item</u>	<u>Description</u>	<u>Material</u>	<u>Part Number</u>	<u>Stock</u>
1.	End Bonnet / In-Out	Cast Iron	203-0005	Yes
2.	End Bonnet / Return	Cast Iron	203-0006	Yes
1.	End Bonnet / In-Out	Cast Bronze	203-0019	Yes
2.	End Bonnet / Return	Cast Bronze	203-0020	Yes
1.	End Bonnet / In-Out	Stainless Steel	203-0042	Yes
2.	End Bonnet / Return	Stainless Steel	203-0043	Yes
3.	Gasket / Front-Back	Hypalon (CORK COMPOSITE)	302-1003	Yes
3.	Gasket / Front-Back	High Temp.(DURLON 8500)	302-1013	Yes
4.	Foot Bracket	Steel	203-0087	Yes
5.	Zinc Anode	Brass Fitting, Zinc Rod	301-0004	Yes

