

SAE-1005-SP Parts List

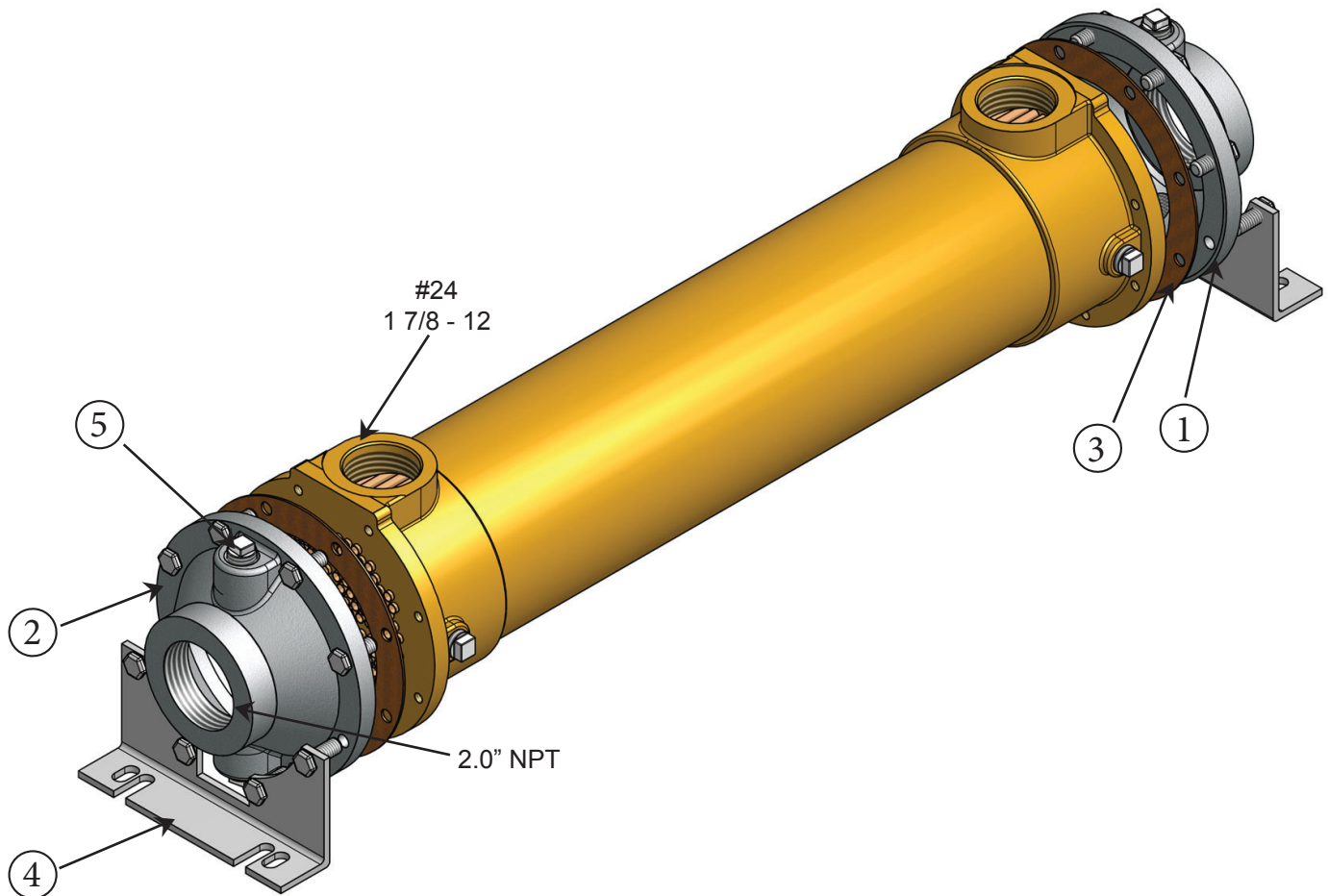

Item	Description	Material	Part Number	Stock
1.	End Bonnet / In-Out	Cast Iron	203-0002	Yes
2.	End Bonnet / In-Out	Cast Iron	203-0002	Yes
1.	End Bonnet / In-Out	Cast Bronze	203-0016	Yes
2.	End Bonnet / In-Out	Cast Bronze	203-0016	Yes
1.	End Bonnet / In-Out	Stainless Steel	203-0039	Yes
2.	End Bonnet / In-Out	Stainless Steel	203-0039	Yes
3.	Gasket / Front-Back	Hypalon (CORK COMPOSITE)	302-1003	Yes
3.	Gasket / Front-Back	High Temp.(DURLON 8500)	302-1013	Yes
4.	Foot Bracket	Steel	203-0087	Yes
5.	Zinc Anode	Brass Fitting, Zinc Rod	301-0004	Yes

