

SAE-1006-SP Parts List

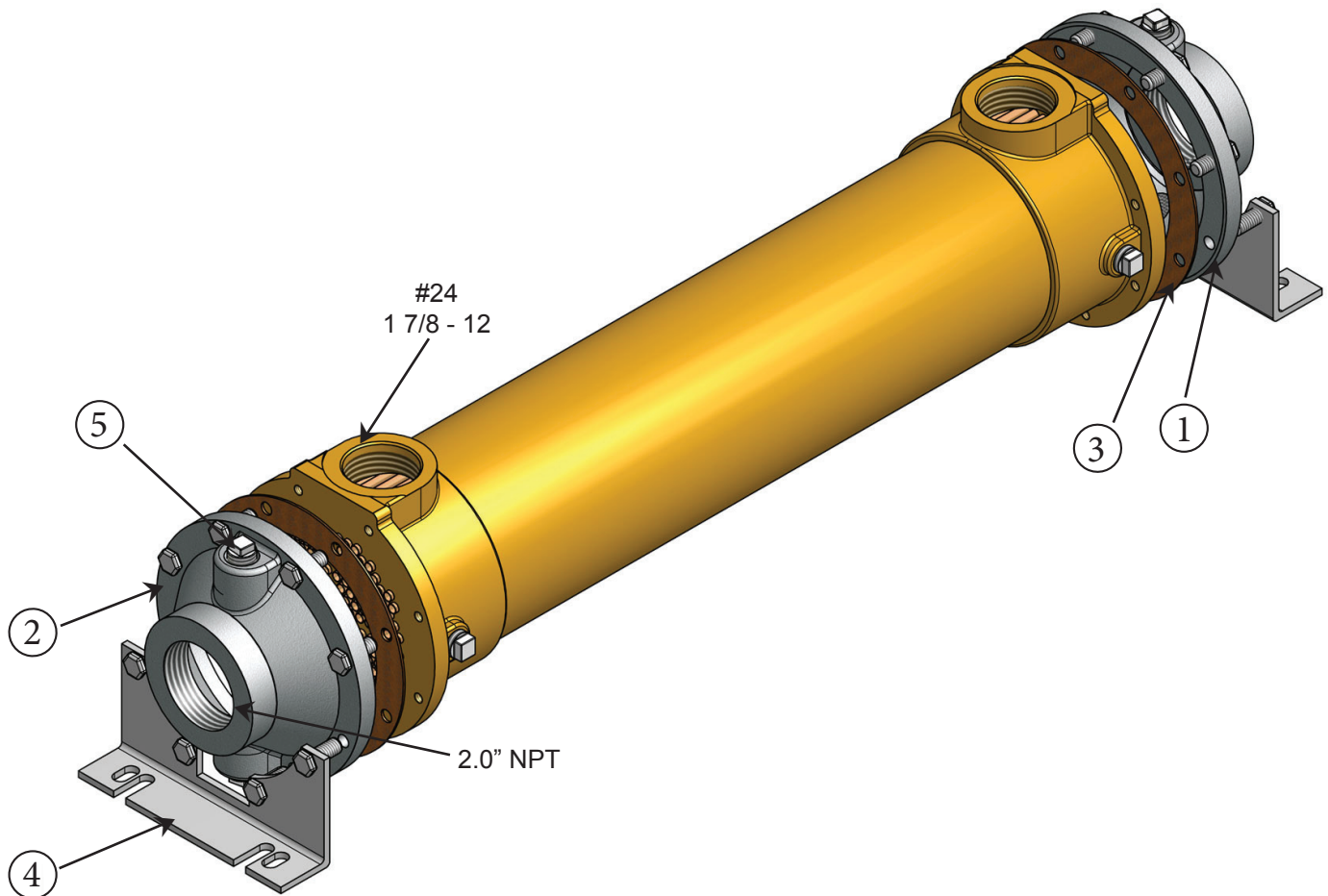

| Item | Description | Material | Part Number | Stock |
|------|---------------------|--------------------------|-------------|-------|
| 1. | End Bonnet / In-Out | Cast Iron | 203-0002 | Yes |
| 2. | End Bonnet / In-Out | Cast Iron | 203-0002 | Yes |
| 1. | End Bonnet / In-Out | Cast Bronze | 203-0016 | Yes |
| 2. | End Bonnet / In-Out | Cast Bronze | 203-0016 | Yes |
| 1. | End Bonnet / In-Out | Stainless Steel | 203-0039 | Yes |
| 2. | End Bonnet / In-Out | Stainless Steel | 203-0039 | Yes |
| 3. | Gasket / Front-Back | Hypalon (CORK COMPOSITE) | 302-1003 | Yes |
| 3. | Gasket / Front-Back | High Temp.(DURLON 8500) | 302-1013 | Yes |
| 4. | Foot Bracket | Steel | 203-0087 | Yes |
| 5. | Zinc Anode | Brass Fitting, Zinc Rod | 301-0004 | Yes |

