

SAE-1202-SP Parts List

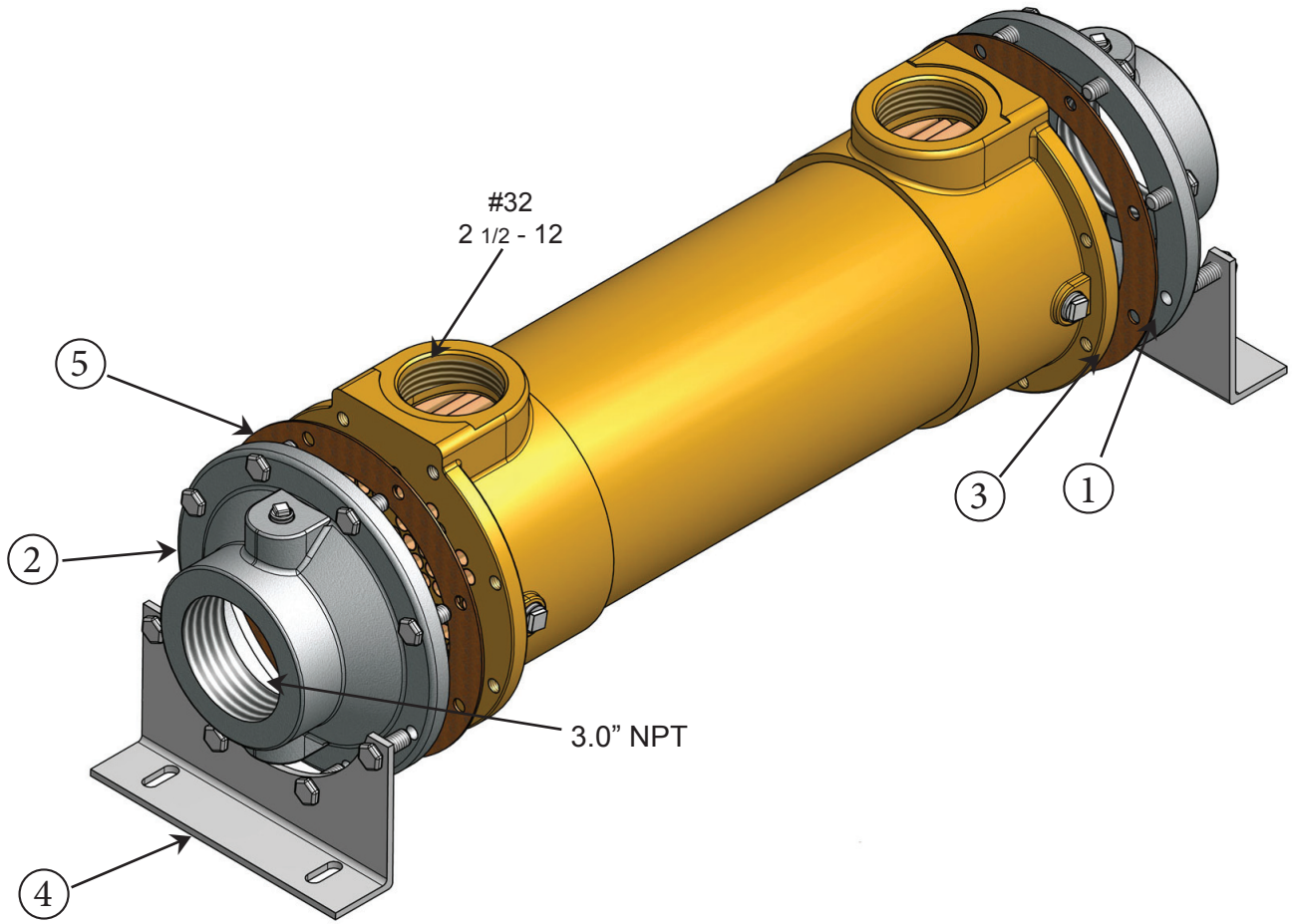

Item	Description	Material	Part Number	Stock
1.	End Bonnet / In-Out	Cast Iron	204-0002	Yes
2.	End Bonnet / In-Out	Cast Iron	204-0002	Yes
1.	End Bonnet / In-Out	Cast Bronze	204-0028	Yes
2.	End Bonnet / In-Out	Cast Bronze	204-0028	Yes
1.	End Bonnet / In-Out	Stainless Steel	204-0071	Yes
2.	End Bonnet / In-Out	Stainless Steel	204-0071	Yes
3.	Gasket / Front-Back	Hypalon (CORK COMPOSITE)	302-1004	Yes
3.	Gasket / Front-Back	High Temp. (DURLON 8500)	302-1014	Yes
4.	Foot Bracket	Steel	204-0007	Yes
5.	Zinc Anode	Brass Fitting, Zinc Rod	301-0003	Yes

