

SAE-402-SP Parts List

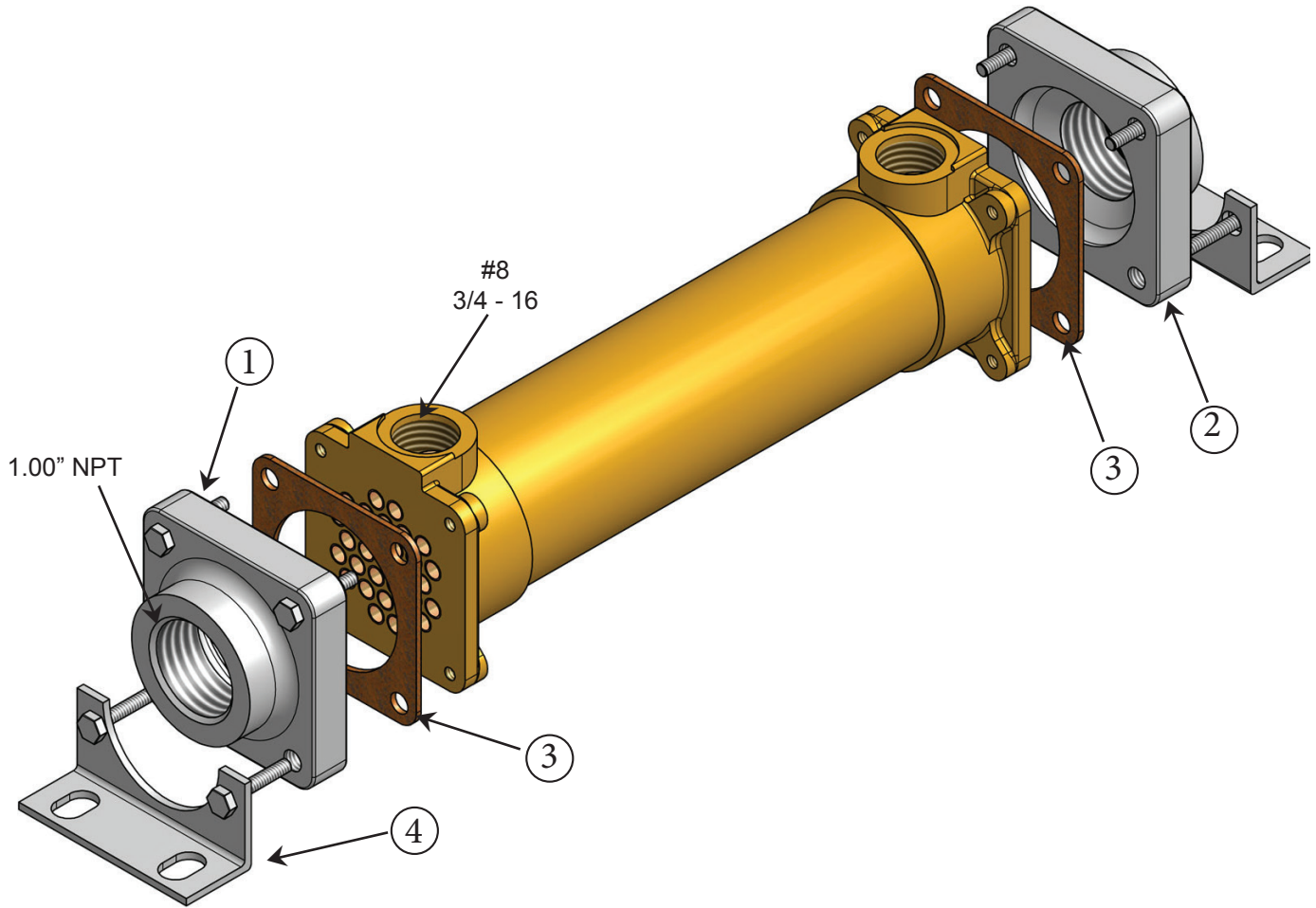

Item	Description	Material	Part Number	Stock
1.	End Bonnet / In-Out	Cast Iron	201-0002	Yes
2.	End Bonnet / In-Out	Cast Iron	201-0002	Yes
1.	End Bonnet / In-Out	Cast Bronze	201-0010	Yes
2.	End Bonnet / In-Out	Cast Bronze	201-0010	Yes
1.	End Bonnet / In-Out	Stainless Steel	201-0013	Yes
2.	End Bonnet / In-Out	Stainless Steel	201-0013	Yes
3.	Gasket / Front-Back	Hypalon (CORK COMPOSITE)	302-1001	Yes
3.	Gasket / Front-Back	High Temp. (DURLON 8500)	302-1011	Yes
4.	Foot Bracket	Steel	201-0003	Yes
5.	Zinc Anode	Brass Fitting, Zinc Rod	301-0004	Yes

