

SAE-705-FP Parts List

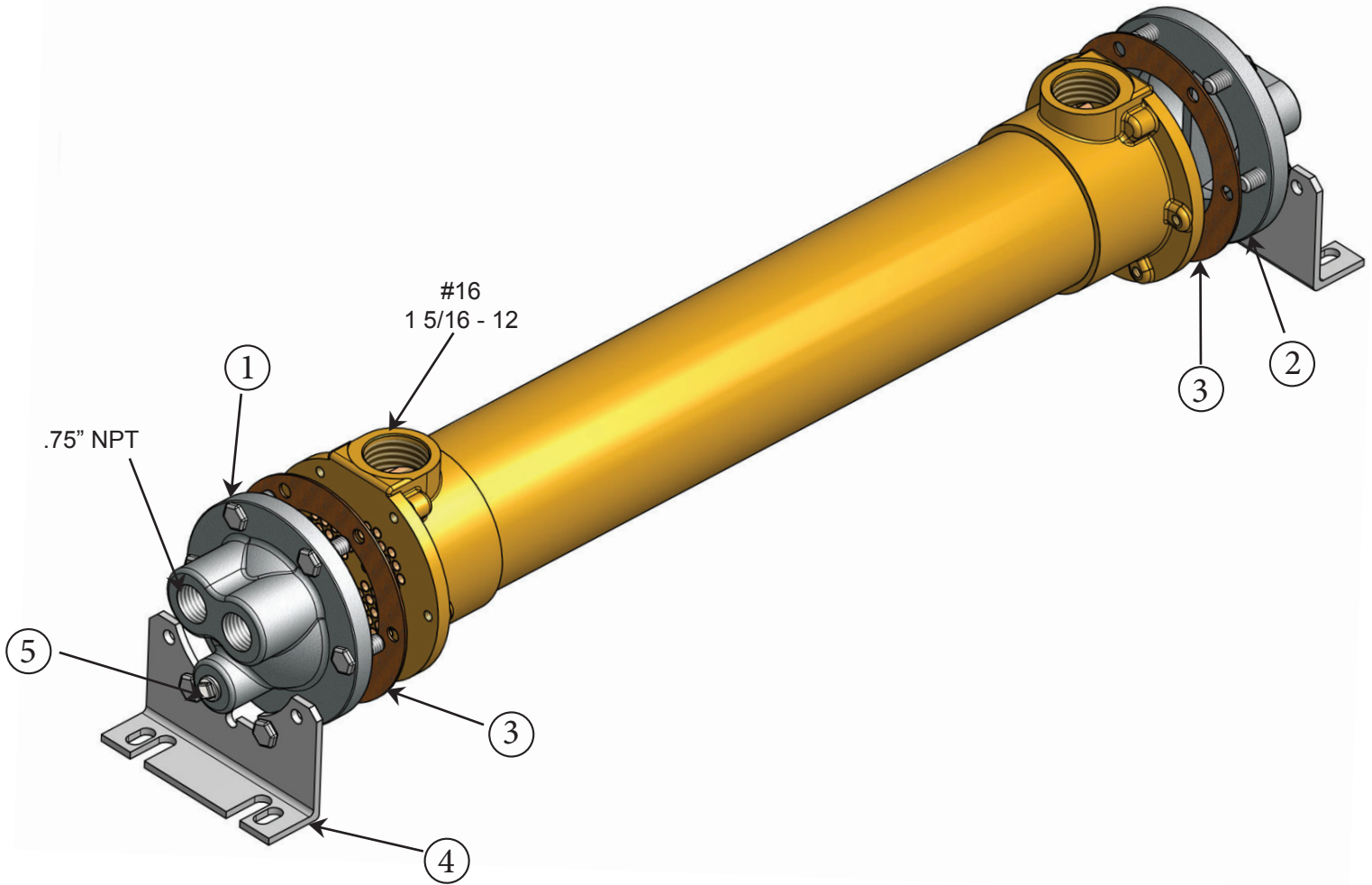

Item	Description	Material	Part Number	Stock
1.	End Bonnet / In-Out	Cast Iron	202-0005	Yes
2.	End Bonnet / Return	Cast Iron	202-0006	Yes
1.	End Bonnet / In-Out	Cast Bronze	202-0027	Yes
2.	End Bonnet / Return	Cast Bronze	202-0028	Yes
1.	End Bonnet / In-Out	Stainless Steel	202-0037	Yes
2.	End Bonnet / Return	Stainless Steel	202-0038	Yes
3.	Gasket / Front-Back	Hypalon (CORK COMPOSITE)	302-1002	Yes
3.	Gasket / Front-Back	High Temp. (DURLON 8500)	302-1080	Yes
4.	Foot Bracket	Steel	203-0007	Yes
5.	Zinc Anode	Brass Fitting, Zinc Rod	301-0004	Yes

